

USER'S MANUAL
TEXI HP-1620F-T



 *texi*

Cautions and Safety Protection

1. Please read all the contents carefully before you operate and use the equipment.
2. The equipment is only used for the pattern thermal transfer printing of clothes, fabric, etc., and the equipment cannot be used for any other purposes.
3. To reduce electric shock hazards, do not use the equipment in places with moisture, corrosive gases and strong vibration. Please don't put the thermal transfer printer in water or other liquids.
4. Hold the plug and unplug it from the socket to cut off power. Please don't pull the power cable directly.
5. Prevent the wire from contact with the hot surface in use, so as not to damage the power cable and produce safety hazards.
6. If the equipment is dropped or damaged, to avoid electric shock, please don't disassemble or attempt to repair this equipment. Please send it to the professional repair staff for inspection and repair. The incorrect assembly or repair will increase the hazards of fire, electric shock or personnel injury when the equipment is used.
7. The equipment cannot be used by people with impaired physical, sensorial or intellectual abilities or lack of experience or knowledge (including children) unless they have been supervised or guided by people responsible for their safety to use the equipment.
8. Juveniles are not allowed to contact the machine unsupervised, even when the machine is not used.
9. The heating surface will be at a high temperature at work. Don't touch it. Please take notice of the warning label and avoid burn.
10. To reduce the overload possibility of the circuits, please don't run other high-voltage equipment in the same circuit.
11. If it is necessary to extend the power cable, use 20A rated power cable. The electrical wire with relatively small rated current may be overheated. Moreover, it is necessary to extend the power cable reasonably to avoid pulling or tripping.

Contents

Cautions and Safety Protection	2
Contents	3
Introduction to the Equipment	4
Operating Procedures	5
Operating Instructions	6-15
I. Connect the Power Cable	6
II. Power On	7
III. Temperature Setup	7
IV. Time Setup	8
V. Pressure Adjustment	9
VI. Heat Press Operation	9-10
VII. Introduction to the Menu Operation	11-15

Introduction to the Equipment

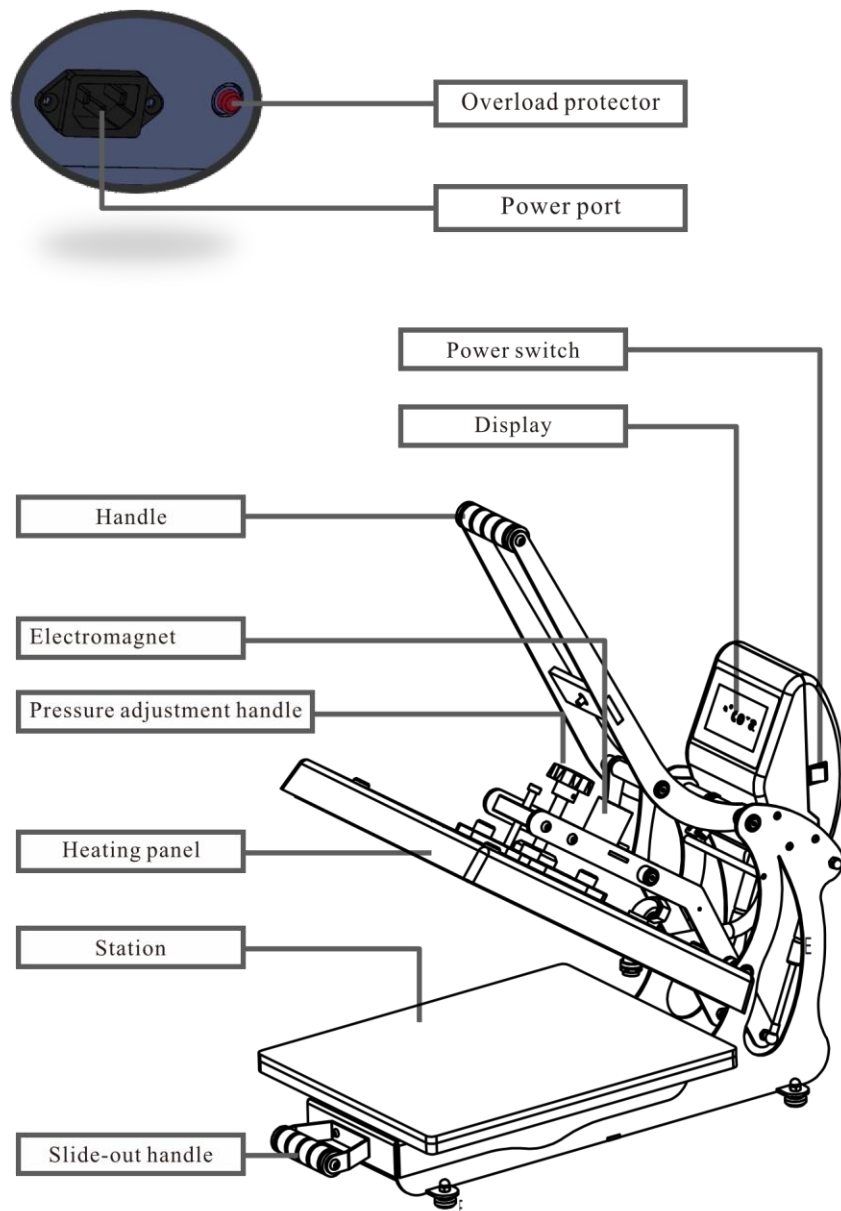

Operating Procedures

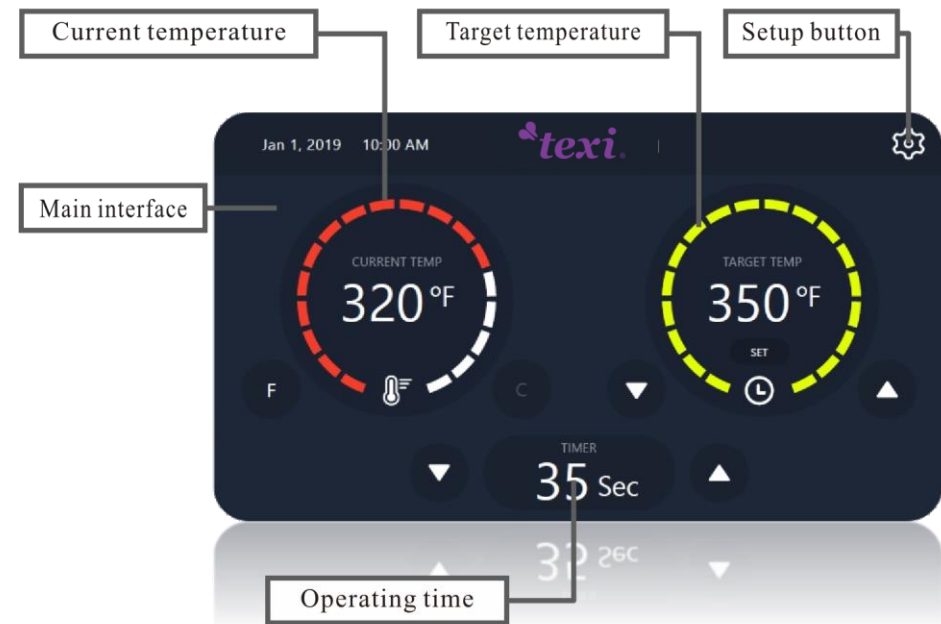

The machine operation instructions are designed for users. Please read it carefully to learn gradually and get the best result.

- Please don't touch the heating press plate in use to avoid scalding.
- Both of your hands should be off the top of the press plate when the press plate is locked, because the pressure may cause injury.
- The Heat Press machine should be put on the solid support at an appropriate height for convenient operation.
- Keep clean, tidy and free from obstacles for the working area.
- Cut off the power cable before cleaning, moving or repairing the heat press machine.

Operating Instructions

I. Connect the Power Cable

Note: The machine adopts intelligent voltage detecting technology and 110V-220V universal, so it is unnecessary to distinguish countries and regions or alter interior circuits. Therefore, it will be very convenient for users to use the machine.

Connect the power cable into the power socket with reliable grounding and enough rated current.

◆ Voltage:

When the working voltage is 120V, more than 20A reliable grounding is required. When the working voltage is 220V, more than 10A reliable grounding is required.

◆ Extension wire:

If necessary, use the extension wire as short as possible and the rated current should be not less than 12A. Heavy-duty wires are recommended.

◆ Circuit:

Don't use the equipment or accessories requiring over 15A or large power (especially more than one set of heat press machine) on the same power source.

Important: If the power cable is damaged, it should be replaced only by the manufacturer, the service agent or qualified personnel to avoid danger. The damaged power cable should be replaced by the same model of 300V power cable.

Warning: If these instructions are not observed, the consequences below may occur

1. The controller will works unsteadily
2. The display will shows incorrect, and the heating plate may works abnormally.
3. The overheating and overload protection will be cut off, and parts of the machine will be damaged under severe circumstances.

Operating Instructions

II. Power On

Note: The machine has an automatic sleep mode. After the machine is stopped for 2h, it will enter the energy-saving sleep mode.

To resume the normal working mode, please press any button on the display, and then the machine will returns to the target temperature automatically.

1. The packaging bolt is on the top of the electromagnet. Before the thermal transfer printer is powered on or the machine is operated, remove the packaging bolt. The packaging bolt is only used during transportation.

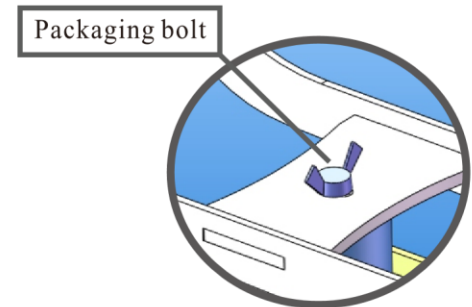

2. Find the power switch on one side of the transfer printer, and then switch on the power switch. Please refer to the location in the picture (right).

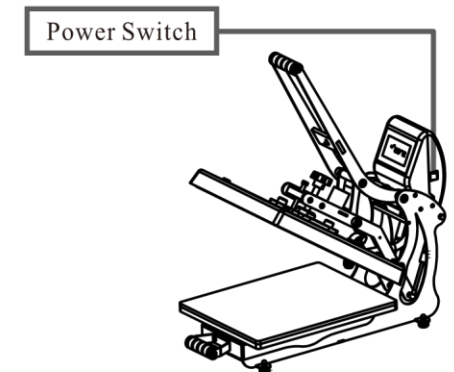

III. Temperature Setup

Note: The Hear Press Machine has a touch screen. Click the screen directly to perform relevant operations.

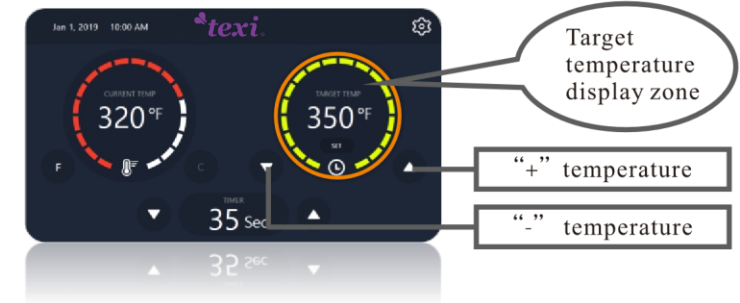

Operating Instructions

Setup method one:

Click ▼/▲ (Shown in the picture above) at both sides of the“TARGET TEMP” in the main interface directly to change the target temperature value.

Setup method two:

Click the“TARGET TEMP”display area in the main interface, and input the temperature to be set in the popup keyboard as shown in the right picture.

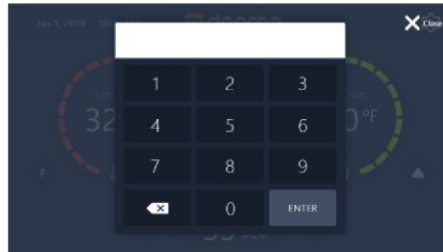

IV. Time Setup

The time setup method is the same as the temperature setup method, and the detailed operation is as follows:

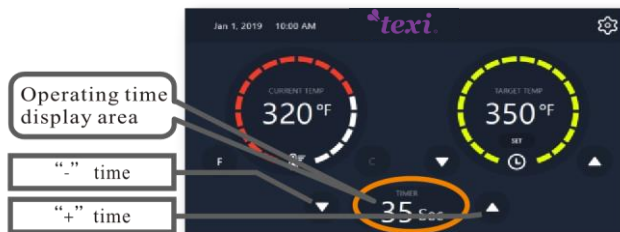

Setup method one:

Click ▼/▲ (Shown in the picture above) at both sides of the“TIME” in the main interface directly to change the operating time.

Setup method two:

Click the“TIME” display area in the main interface, and input the time to be set in the pop up keyboard as shown in the right picture.

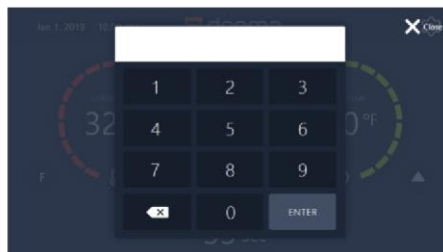

Operating Instructions

V. Pressure Adjustment

When it is necessary to adjust the pressure, turn the pressure adjustment knob on the machine. Turn left to reduce the pressure, and turn right to increase the pressure. The specific operation to adjust the knob position can refer to the picture below:

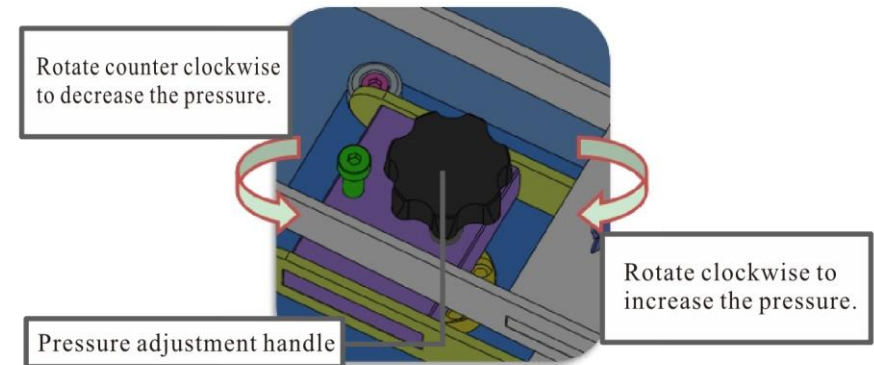

Remember: take the thickness of the caps into account when adjusting the pressure
Warning: The structural damage caused by excessive pressure is not covered by the warranty.

VI. Heat Press Printing Machine Operation

When the equipment reaches the target temperature, put the clothes ready for ironing. Press down the operation handle and move the heating press plate to the pressure locking position, and the timing procedure starts automatically.

When countdown is to the last 3 seconds, the machine will give out “beeping” warning to remind the user that the thermal transfer printing will be done soon. When the timing is over, the thermal transfer printer returns to the original position automatically.

Then the operation cycle is done, and the next operation cycle may be started.

High Temperature
Danger of Scalding

Automatic Opening
Keep Away!

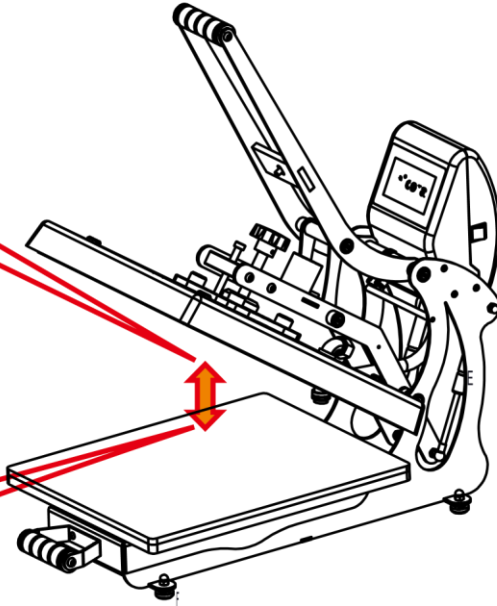

Note:

1. When the clothes are been placed down, please avoid contact of arms, hands, etc. with the heating press plate to avoid scalding.
2. When the timing is over, the thermal transfer printer opens and returns to the original position automatically. Keep your hands and arms off the machine. Mind your personal safety!

VII. Introduction to the Menu Operation

The menu option is used to set up the language, temperature, date//time, production statistics and parameters etc. Click the “setup” button on the top right corner of the screen to enter the system setup interface.



1. Language Setup

The system has three language options: Chinese, English and Spanish. Click the “language” in the menu, and enter the language setup interface. Click the language to be used in the screen, the language will be highlighted and changed for the system, as shown in the picture below:

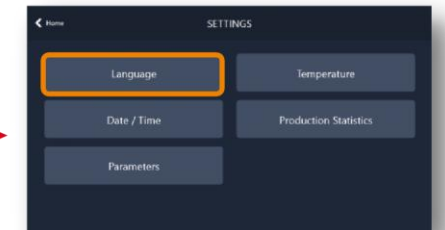
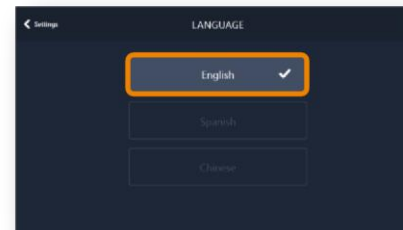

2. Temperature Unit

The system has two temperature units in “°C” and “°F”, and the detailed switch-over operation is as follows:

Operating Instructions

Operating Instructions

Method one:

1. Click the “temperature” option in the setup interface.

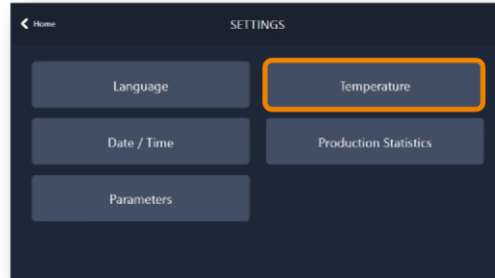

2. When the system enters the “temperature units” interface, click the temperature unit to be used, and the option is highlighted.

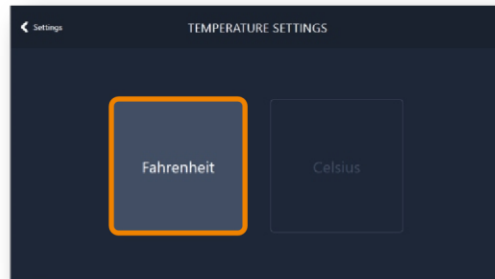

Method Two:

Long press the “°C” and “°F” at both sides of the “current temperature” in the main display interface for direct switch-over, and the button icon will be highlighted.

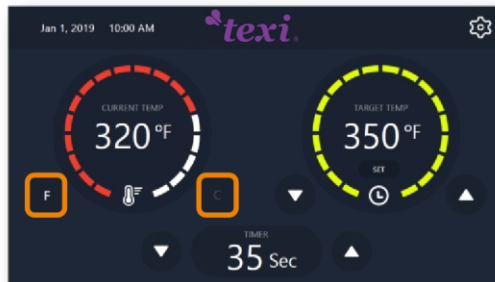

3. Date Setup

Click the “date/time” in the setup interface, and enter the date/time setup interface. Slide the corresponding time and date to change the date and time, and then click “save”.

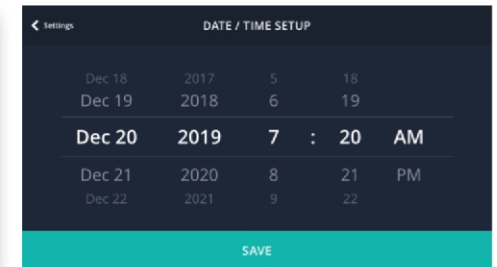
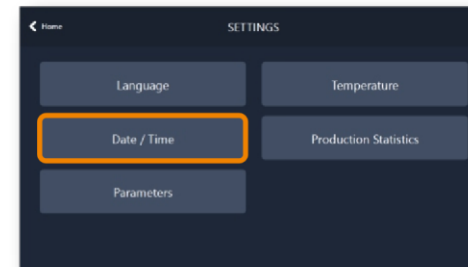

4. Production Statistics

Click the “Production Statistics” in the setup interface to check the total production quantity in the current day.

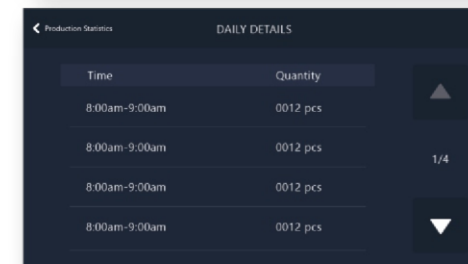
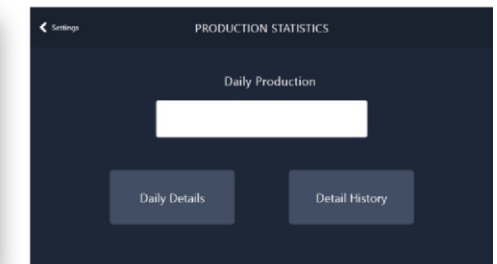
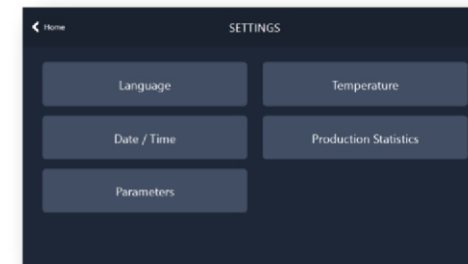

Click the “Daily Details”, and the system will display the daily details and the production quantity in different periods of the day.

Click “historic breakdown”, and the system displays the historic breakdown list, including the daily production quantity in the last month.

Date	Quantity	
01-01-2019	0012 pcs	
01-01-2019	0012 pcs	1/4
01-01-2019	0012 pcs	
01-01-2019	0012 pcs	

5. Parameter

Use the “Parameters” menu to create, save and check the parameters. The system can save 99 process parameters at most. Click the “Parameters” in the setup interface, and enter the parameters interface.

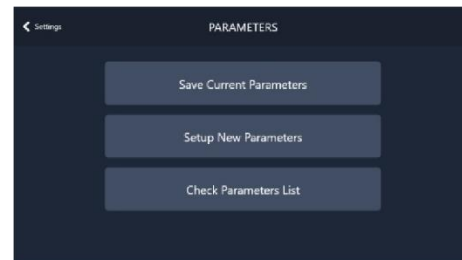
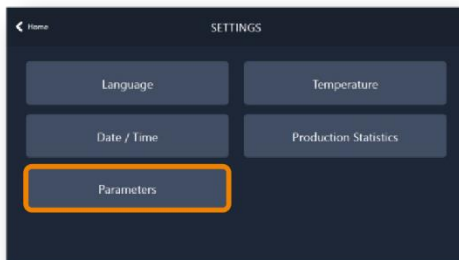

(1) Save Current Parameters

“Save Current Parameters” means saving the temperature and time set up in the main interface, and the system will remind you of inputting the current process parameter after clicking. After the input is done, click “Save”, and the process parameter is saved into the parameter list.

Enter current parameters name:

Temperature: 350 °F Time: 35 sec

SAVE

You already have parameters with this name. Would you like to replace the original with this one?

YES NO

Note: When the name to be input is repeated, the system will remind if it is needed to replace the parameter under the same name. Then it is necessary to make corresponding choices based on needs.

(2) Set up New Parameters

The user may save the parameters by “Set up New Parameters”. Click the “Set up New Parameters” in the parameter list, input the name, temperature and time in the corresponding input boxes, and then click “Save”.

Parameters SET UP NEW PARAMETERS

Name: [input field]

Temperature: [input field] °F

Time: [input field] sec

SAVE



Note: When the name to be input is repeated, the system will remind if it is needed to replace the parameter under the same name.

(3) Check Parameter List

The parameters table stores detailed information about different working parameters setup by the user, and the system can store 99 working parameters at most. The user can check, show and edit the working parameters through the list.

When the user needs to check, show and edit the process parameters, the user can click the option button **...** next to the corresponding parameter to show relevant operation keys, as shown in the picture below:

Name	Temp	Time	Action
Name	350°	35sec	...
Name	350°	35sec	...
Name	350°	35sec	...
Name	350°	35sec	...

-  : Use the current parameter
-  : Delete the current parameter
-  : Edit the current parameter

Name	Temp	Time	Action
Name	350°	35sec	✓ ✎ 🗑
Name	350°	35sec	...
Name	350°	35sec	...
Name	350°	35sec	...